

Space Saving Cable Management Rack Systems

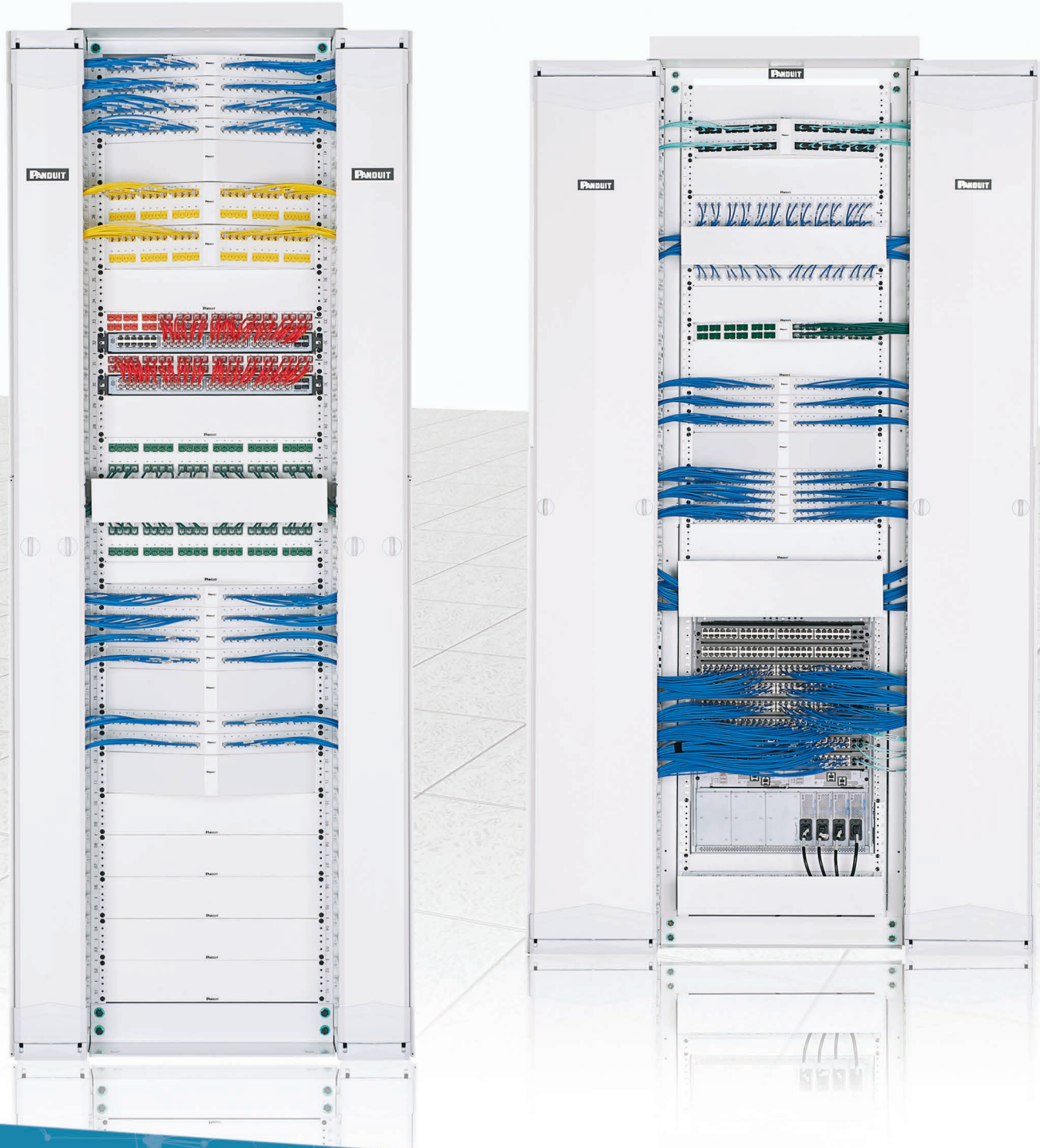

Maximize Space Utilization, Enhance Network Reliability

The trend towards consolidation, virtualization and automation in the enterprise is driving the need to maximize space utilization to reduce capital expenditures and operational costs while maintaining network reliability and availability. This trend is placing greater demands on the physical infrastructure to help manage growing cable densities, larger network equipment and increasing energy usage.

Space Optimized, High Capacity Cable Management Systems

Panduit builds on years of experience as a leader in cable management, integrating best practices and application knowledge to develop highly reliable and efficient physical infrastructure solutions. Panduit's comprehensive offering of vertical cable management, horizontal cable management, and rack solutions reduces space required to route, manage and protect high cable capacities, providing the lowest total cost of ownership. These product sets can be combined to provide an optimized solution for virtually any application. PatchRunner™ 2 Enhanced Vertical Cable Manager with Vertical Patching and PatchRunner™ 2 Vertical Cable Management Systems address the needs of the data center and telecommunications rooms to deliver improved network performance and reduced real estate costs. Superior cable management features and innovative vertical RU mounting maximize capacity and enable efficient moves, adds, and changes to reduce operational costs.

PatchRunner™ 2 Enhanced Vertical Cable Management System with Vertical Patching

PatchRunner™ 2 Enhanced Vertical Cable Managers with Vertical Patching are optimized to provide the maximum amount of capacity, flexibility and accessibility for high density switch and server applications.

PatchRunner™ 2 Vertical Cable Management System

PatchRunner™ 2 Vertical Cable Managers are designed to provide the best combination of features and value for high density enterprise telecommunications rooms and data center applications.

2 Post and 4 Post Racks

PatchRunner™ 2 Vertical Cable Manager and PatchRunner™ 2 Enhanced Vertical Cable Manager with Vertical Patching Systems can be seamlessly integrated into Panduit's versatile 2 post and 4 post racks. Designed for today's larger network equipment, Panduit racks provide strength, capacity and thermal features that help ensure network availability. The 2 post and 4 post rack thermal accessories provide proper heat dissipation of active equipment, improving network reliability.

Reduce Real Estate Cost and Space Utilization by **35%** with Panduit PatchRunner™ 2 Vertical Cable Management Systems

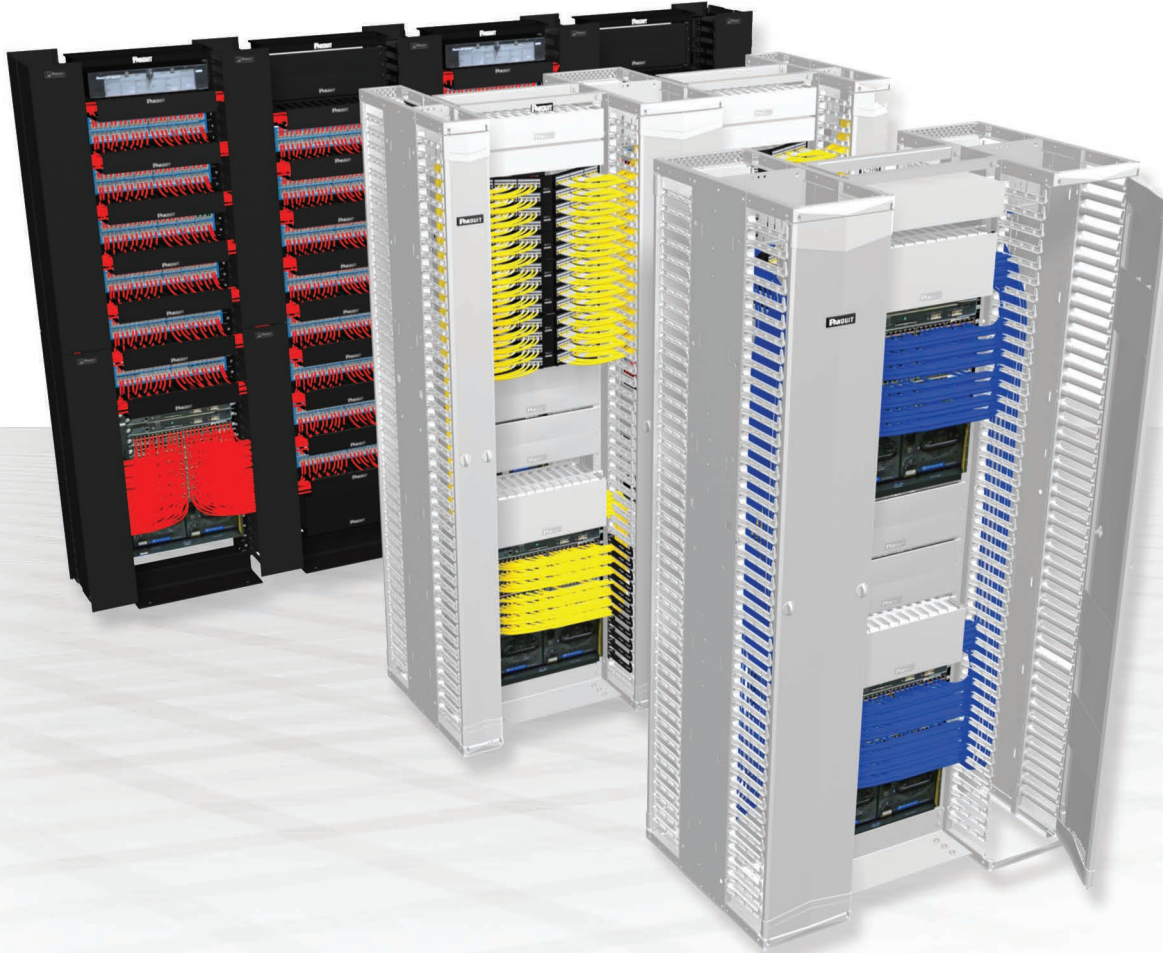

Floor Space Required

Layout	NetRunner™ Vertical Cable Management System	PatchRunner™ 2 Vertical Cable Management System	PatchRunner™ 2 Enhanced Vertical Cable Management System with Vertical Patching
Total Square Feet	38.9	20.1	12.5
Annual Real Estate Costs (Based on \$61/square foot, in a 10-TR building)	\$23,729	\$12,261	\$7,625
Lifetime Real Estate Costs (Based on a 50-year building life)	\$1,186,450	\$613,050	\$381,250

Refer to page 18 and 19 for capacity and space requirements for specific solutions.

PatchRunner™ 2 Enhanced Vertical Cable Manager Application

The right solution helps manage equipment, connectivity, and available space for maximum density, scalability and usability. PatchRunner™ 2 Enhanced Vertical Cable Management System with Vertical Patching offers the highest cable capacities for maximum densities, scalability, and superior space utilization. The patching configuration is not a true application, but rather demonstrates versatility for customization to fit your requirements.

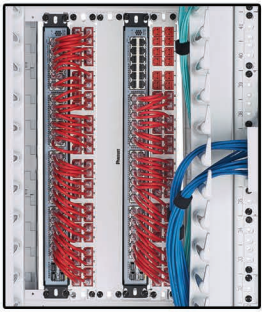

Direct Switch Patching with 8-Inch Patch Cords



Various Accessories Such as Strain Relief Bars



Blanking Panels



Bend Radius Control Clips

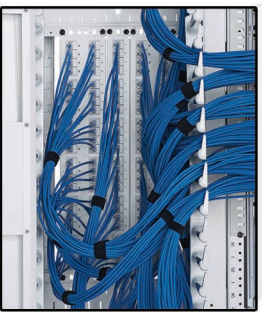

Vertical Patching



Brush-Panel Pass Through Devices

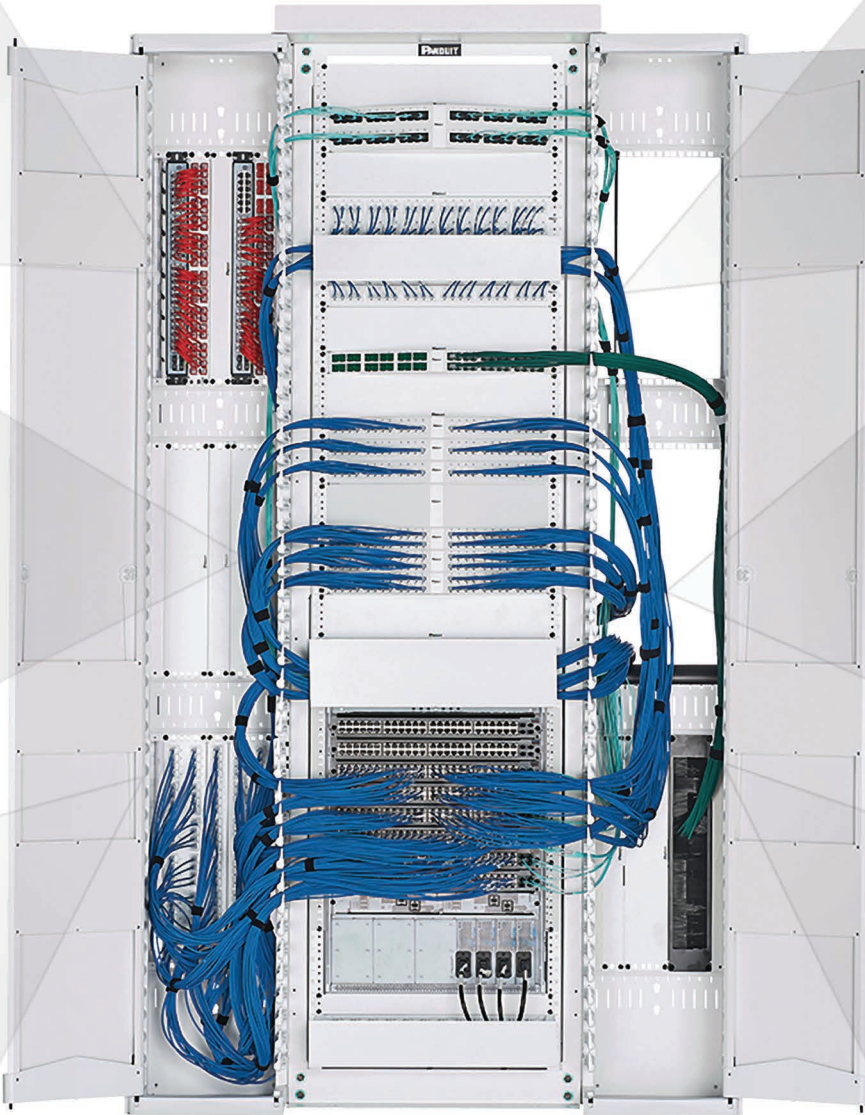

PatchRunner™ 2 Vertical Cable Manager Application

PatchRunner™ 2 Vertical Cable Manager is designed to manage high density networking equipment in, up to, half the area required by traditional cable management systems. The reduction in square footage combined with fewer components ordered, inventoried, and installed results in significant cost savings for the network infrastructure.

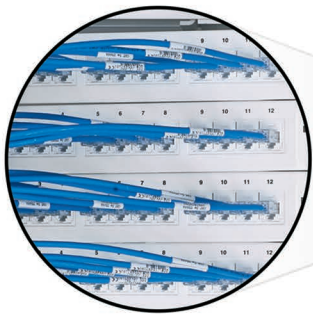

28 AWG Patch Cords

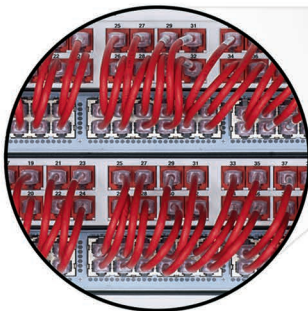

Direct Switch Patching with 8-inch Patch Cords

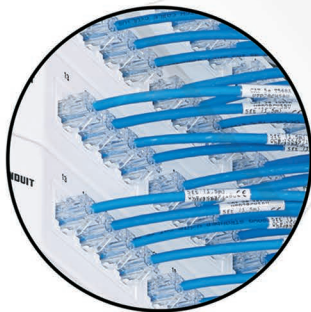

Angled Patch Panels

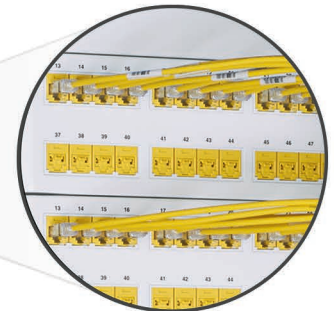
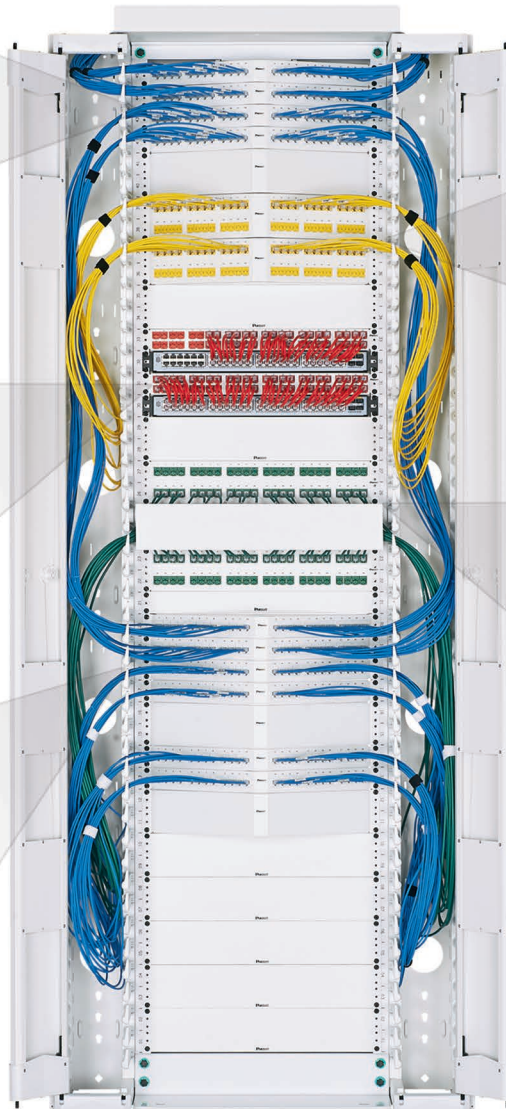

Block-Out Devices with Angled Patching

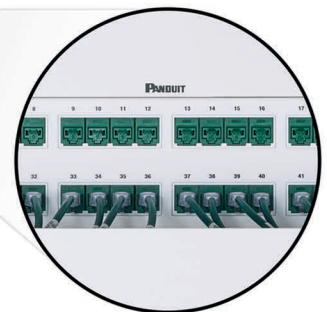

Block-Out Devices with Horizontal Cable Manager Patching

PatchRunner™ 2 Enhanced Vertical Cable Management System with Vertical Patching

1 4 Post Rack

R4P

84.0"H x 23.25"W x 30.0"D
45 rack spaces

R4P23

84.0"H x 23.25"W x 23.0"D
45 rack spaces

R4P36

84.0"H x 23.25"W x 36.0"D
45 rack spaces

R4P42

84.0"H x 23.25"W x 41.5"D
45 rack spaces



The capacity of this vertical manager is ideal for Category 6A cabling or other cabling systems. Integral EIA zero rack space mounting capability in the back of the manager allows equipment to be patched in the PatchRunner™ 2 Enhanced Vertical Cable Manager with Vertical Patching, freeing up valuable rack space for equipment and allowing the use of shorter length patch cords.

2a PE2VD06 – 6" wide

- PatchRunner™ 2 Enhanced Vertical Cable Manager with Vertical Patching (double-sided)
- Available in 6", 8", 10", and 12" widths
- Available in 6, 9, 12, and 15 vertical RU spacing



2b PE2VFD08 – 8" wide

- PatchRunner™ 2 Enhanced Vertical Cable Manager with Vertical Patching (single-sided)
- Available in 6", 8", 10", and 12" widths
- Available in 6, 9, 12, and 15 vertical RU spacing



3a CPPLA48WBLY – 2 RU, 48-Port

- Mini-Com® Modular Patch Panel
- Comes with faceplates, labels, and label covers

3b CPPLA24WBLY – 1 RU, 24-Port

- Mini-Com® Modular Patch Panel
- Comes with faceplates, labels, and label covers

4 NM4 – Horizontal Cable Manager, 4 RU

- NetManager® High Capacity Horizontal Cable Manager
- Organizes and protects network cabling



5 RSHLF – 4 Post Rack Mount Shelf

- Uses equipment mounting flanges to support large network equipment
- 30 inch depth



PatchRunner™ 2 Enhanced Vertical Cable Management System with Vertical Patching



- High capacity minimizes area required for network layout, freeing up valuable floor space
- Allows vertical mounting of many standard EIA 19" accessories, such as patch panels
- Closed off side panels provide better airflow management for hot and cold aisle air containment solutions

- Large finger spacing accommodates up to 48 Category 6A cables
- Best-in-class dual hinged metal doors provide easy access to the vertical pathway and provide audible feedback when closing
- Doors ship with managers, simplifying ordering process with less packaging waste



PE2VD12



PE2VFD12

Black Part Number	White Part Number	Height In. (mm)	Width In. (mm)	Depth In. (mm)	No. of Rack Units	Single or Double Sided	No. of Doors Included	Vertical RU Spacing	Std. Pkg. Qty.	
PE2VD06	PE2VD06WH	84.0 (2130)	6.0 (152)	26.8 (681)	45	Double-Sided	Two	6	1	
PE2VD08	PE2VD08WH	84.0 (2130)	8.0 (203)	26.8 (681)				9		
PE2VD10	PE2VD10WH	84.0 (2130)	10.0 (254)	26.8 (681)				12		
PE2VD12	PE2VD12WH	84.0 (2130)	12.0 (305)	26.8 (681)				15		
PE2VFD06	PE2VFD06WH	84.0 (2130)	6.0 (152)	16.3 (415)		Single-Sided	One	6		
PE2VFD08	PE2VFD08WH	84.0 (2130)	8.0 (203)	16.3 (415)				9		
PE2VFD10	PE2VFD10WH	84.0 (2130)	10.0 (254)	16.3 (415)				12		
PE2VFD12	PE2VFD12WH	84.0 (2130)	12.0 (305)	16.3 (415)				15		
PE2VSD06	PE2VSD06WH	84.0 (2130)	6.0 (152)	26.8 (681)		52	Double-Sided	Two		6
PE2VSD08	PE2VSD08WH	84.0 (2130)	8.0 (203)	26.8 (681)						9
PE2VSD10	PE2VSD10WH	84.0 (2130)	10.0 (254)	26.8 (681)						12
PE2VSD12	PE2VSD12WH	84.0 (2130)	12.0 (305)	26.8 (681)						15
PE2VD0696	PE2VD0696WH	96.0 (2435)	6.0 (152)	26.8 (681)	Single-Sided		One	6		
PE2VD0896	PE2VD0896WH	96.0 (2435)	8.0 (203)	26.8 (681)				9		
PE2VD1096	PE2VD1096WH	96.0 (2435)	10.0 (254)	26.8 (681)				12		
PE2VD1296	PE2VD1296WH	96.0 (2435)	12.0 (305)	26.8 (681)				15		
PE2VFD0696	PE2VFD0696WH	96.0 (2435)	6.0 (152)	16.3 (415)	Double-Sided		One	6		
PE2VFD0896	PE2VFD0896WH	96.0 (2435)	8.0 (203)	16.3 (415)				9		
PE2VFD1096	PE2VFD1096WH	96.0 (2435)	10.0 (254)	16.3 (415)				12		
PE2VFD1296	PE2VFD1296WH	96.0 (2435)	12.0 (305)	16.3 (415)				15		
PE2VSD0696	PE2VSD0696WH	96.0 (2435)	6.0 (152)	26.8 (681)	Double-Sided	One	6			
PE2VSD0896	PE2VSD0896WH	96.0 (2435)	8.0 (203)	26.8 (681)			9			
PE2VSD1096	PE2VSD1096WH	96.0 (2435)	10.0 (254)	26.8 (681)			12			
PE2VSD1296	PE2VSD1296WH	96.0 (2435)	12.0 (305)	26.8 (681)			15			

PatchRunner™ 2 Vertical Cable Management System

1 2 Post Rack

- R2P**
84.0"H x 20.3"W x 3.0"D
45 rack spaces
aluminum
- R2P96**
96.0"H x 20.3"W x 3.0"D
52 rack spaces
aluminum



Provides cost effective solutions that organize, manage, protect and showcase network cabling while ensuring system performance and reliability. Optimal compatibility with Panduit racks, patch panels, and connectivity provides a complete end-to-end solution.

2 PR2VD12

- 12"W Front and Rear PatchRunner™ 2 Vertical Cable Manager with doors – 45 rack spaces



3 R2PPR2VWF

- Rack Top Trough with Waterfall creates pathway above rack



4 PR2VEP

- End Panel for PatchRunner™ 2 Vertical Cable Managers



5 CMPH2

- 2 RU Open-Access™ Horizontal Cable Manager D-rings



6 WMP1E

- 2 RU PatchLink™ Horizontal Cable Manager



7 NM2

- 2 RU NetManager™ High Capacity Horizontal Cable Manager



8 R2PPDUB

- Power Distribution Unit (PDU) bracket for 2 and 4 post racks

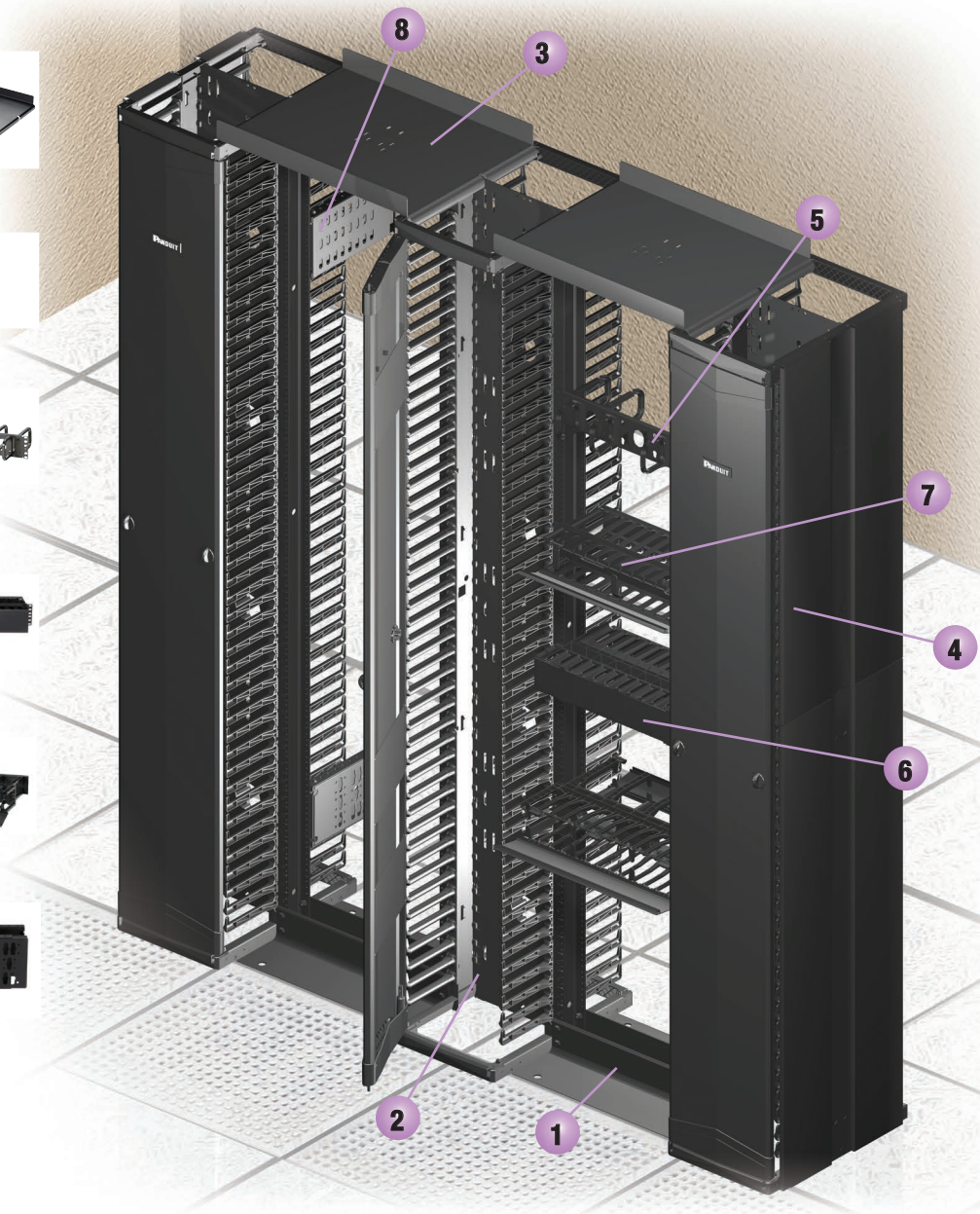

PatchRunner™ 2 Vertical Cable Managers

- Large finger openings accommodate up to 48 Category 6A cables
- “Push-to-close” door design allows for easy operation
- Integral cable retainer on ends of each finger contain cables within each rack unit
- No assembly required; faster installation while reducing labor costs
- Doors ship with managers, simplifying ordering process with less packaging waste



PR2VD12



PR2VFD06



PR2VD12WH



PR2VFD12WH

Part Number	Height	Width	Depth	No. of Rack Units	Single or Double-Sided	No. of Doors Included	Color	Std. Pkg. Qty.
PR2VD0679	79.0" (2003mm)	6.0" (152mm)	20.6" (523mm)	42	Double-Sided	Two	Black	1
PR2VD1279		12.0" (305mm)	20.6" (523mm)		Double-Sided			
PR2VFD0679		6.0" (152mm)	12.0" (305mm)		Single-Sided	One		
PR2VFD1279		12.0" (305mm)	12.0" (305mm)		Single-Sided			
PR2VD06	84.0" (2130mm)	6.0" (152mm)	20.6" (523mm)	45	Double-Sided	Two		
PR2VD08		8.0" (203mm)	20.6" (523mm)		Double-Sided			
PR2VD10		10.0" (254mm)	20.6" (523mm)		Double-Sided			
PR2VD12		12.0" (305mm)	20.6" (523mm)		Double-Sided			
PR2VFD06		6.0" (152mm)	12.0" (305mm)		Single-Sided	One		
PR2VFD08		8.0" (203mm)	12.0" (305mm)		Single-Sided			
PR2VFD10		10.0" (254mm)	12.0" (305mm)		Single-Sided			
PR2VFD12		12.0" (305mm)	12.0" (305mm)		Single-Sided			
PR2VSD06		6.0" (152mm)	20.6" (523mm)		Double-Sided			
PR2VSD08		8.0" (203mm)	20.6" (523mm)		Double-Sided			
PR2VSD10		10.0" (254mm)	20.6" (523mm)		Double-Sided			
PR2VSD12		12.0" (305mm)	20.6" (523mm)		Double-Sided			
PR2VD0696	96.0" (2435mm)	6.0" (152mm)	20.6" (523mm)	52	Double-Sided	Two		
PR2VD0896		8.0" (203mm)	20.6" (523mm)		Double-Sided			
PR2VD1096		10.0" (254mm)	20.6" (523mm)		Double-Sided			
PR2VD1296		12.0" (305mm)	20.6" (523mm)		Double-Sided			
PR2VFD0696		6.0" (152mm)	12.0" (305mm)		Single-Sided	One		
PR2VFD0896		8.0" (203mm)	12.0" (305mm)		Single-Sided			
PR2VFD1096		10.0" (254mm)	12.0" (305mm)		Single-Sided			
PR2VFD1296		12.0" (305mm)	12.0" (305mm)		Single-Sided			
PR2VSD0696		6.0" (152mm)	20.6" (523mm)		Double-Sided			
PR2VSD0896		8.0" (203mm)	20.6" (523mm)		Double-Sided			
PR2VSD1096		10.0" (254mm)	20.6" (523mm)		Double-Sided			
PR2VSD1296		12.0" (305mm)	20.6" (523mm)		Double-Sided			

For all part numbers, add "WH" to end of part number for White product.

4 Post Cable Management Rack System

1 4 Post Rack

R4P36CN

Cage nut rails
84.0"H x 23.25"W x 36.0"D
45 rack spaces

R4P42CN

Cage nut rails
84.0"H x 23.25"W x 41.5"D
45 rack spaces



Deep 4 post open server racks provide the necessary environment for high density server applications. The open design assures maximum ventilation while minimizing air mixing in hot/cold aisle configurations. Space in the rear of the 4 post racks allows for server power, cable management and patching, providing an efficient and functional server solution.

2 R4PFP

• Vertical Blanking Panel



3 CVPDUB

• PDU
Mounting Brackets



4 CVPPB

• Vertical Patch Panel
Mounting Bracket



5 RCSTR

• Caster set



6 R4PFL

• Vertical finger section for
cable management

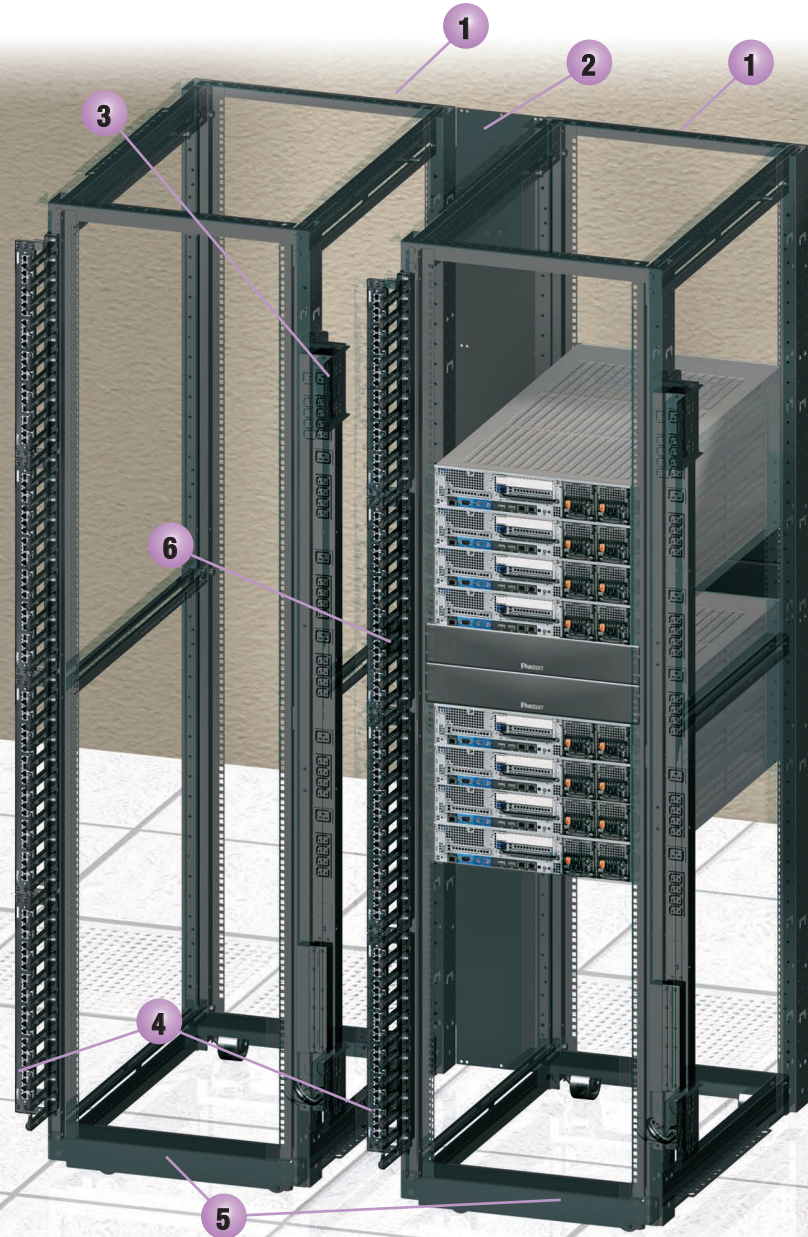
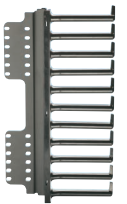

4 Post Rack System configured for server application.

4 Post Cable Management Rack System and Accessories



- Offered in 23", 30", 36" and 42" depths
- Offered in 84" and 96" heights
- Fully adjustable rails can be adjusted after rack is secured to floor

- Cage nut rails for server applications and tapped rails for switch applications
- 2,500 lbs. (1134 kg) load rating, UL Listed



R4P

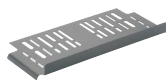

R4PWF

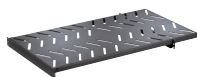

RSHLF



CVPPB



CNSPE



CVPDUB



R4PFL

Part Number	Part Description	No. of Rack Spaces‡	Std. Pkg. Qty.
4 Post Rack Threaded Rail			
R4P23*	Dimensions: 84.0"H x 23.25"W x 23.0"D (2134mm x 591mm x 584mm).	45	1
R4P*	Dimensions: 84.0"H x 23.25"W x 30.0"D (2134mm x 591mm x 762mm).	45	1
R4P36*	Dimensions: 84.0"H x 23.25"W x 36.0"D (2134mm x 591mm x 914mm).	45	1
R4P42*	Dimensions: 84.0"H x 23.25"W x 41.5"D (2134mm x 591mm x 1054mm).	45	1
4 Post Rack Accessories			
R4PWF	Top trough with waterfall creates pathway above rack. Dimensions: 1.9"H x 26.1"W x 8.5"D (50mm x 662mm x 216mm).	—	1
RSHLF23	4 post rack mount shelf. Load rating 275 lbs.(124.7 kg). Dimensions: 1.7"H x 19.0"W x 23.0"D (44mm x 483mm x 584mm).	1	1
RSHLF	4 post rack mount shelf. Load rating 275 lbs. (124.7 kg). Dimensions: 1.7"H x 19.0"W x 30.0"D (44mm x 483mm x 762mm).	1	1
RSHLF36	4 post rack mount shelf. Load rating 275 lbs. (124.7 kg). Dimensions: 1.7"H x 19.0"W x 36.0"D (44mm x 483mm x 914mm).	1	1
R4PFP	Adjustable vertical filler panel for Panduit 4 post racks blocks by-pass air and directs cold airflow through equipment when used.	45	1
RCSTR	4 post rack casters.	—	1
CVPPB	Bracket to vertically mount 1 RU EIA 19" copper and fiber patch panels to the side of the Net-Access™ Cabinet Posts or 4 post racks.	—	1
CNSPE	Net-Access™ Network Cabinet and 4 post rack end channel slack spools. Package includes one left and one right slack spool and mounting brackets.	—	1
CVPDUB	Bracket for vertical PDU mounting to the side of the Net-Access™ Cabinet posts or 4 post racks (kit of two).	—	1
R4PFL	Left vertical finger section for cable management.	11	1
R4PFR	Right vertical finger section for cable management.	11	1
R4PFM	Finger managers for 7 and 8 foot Panduit 4 post racks.	20	2

*For 7' 4 Post Rack Cage Nut Rail add suffix CN to the end of the part number, for example, R4P23CN.
 NOTE: For 8' 4 Post Rack Threaded Rail, add suffix 96 to the end of the part number, for example, R4P2396. For 8' 4 Post Rack Cage Nut, add suffix CN96 to the end of the part number, for example, R4P23CN96.

‡One rack space = 1.75" (44.45mm).

All product color is black.

7ft 30"D and 36"D 4-post racks are available in white. Add "WH" to end of part number. Examples: R4PWH and R4PCNWH.

2 Post Cable Management Rack System and Accessories

- Offered in 84" (2134mm) and 96" (2441mm) versions for both the three inch deep channel rack and six inch deep channel rack
- Rack space identification is printed numbers up allowing quick and easy equipment installation and identification
- Fully bonded structure
- 3" (76mm) deep channel, 1000 lb. (454 kg) load rating, UL listed
- 6" (152mm) deep channel, 1500 lb. (680 kg) load rating, UL listed
- Perforated rails for cable access and side-to-side airflow switches [6" (152mm) depth only]



R2P

R2P6S



PE2VWF



R2PPDUB

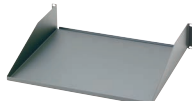

SRM19FM2

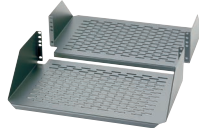

SRM19CMV3

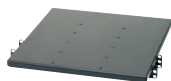

SRM19X18A1

Part Number	Part Description	No. of Rack Spaces‡	Std. Pkg. Qty.
-------------	------------------	---------------------	----------------

3" Deep Channel Rack

R2P	19" EIA rack, aluminum. Dimensions: 84.0"H x 20.3"W x 3.0"D (2134mm x 514mm x 76mm).	45	1
R2P96	19" EIA rack, aluminum. Dimensions: 96.0"H x 20.3"W x 3.0"D (2438mm x 514mm x 76mm).	52	1
R2PS	19" EIA rack, steel. Dimensions: 84.0"H x 20.3"W x 3.0"D (2134mm x 514mm x 76mm).	45	1
R2PW	23" EIA rack, aluminum. Dimensions: 84.0"H x 24.3"W x 3.0"D (2134mm x 616mm x 76mm).	45	1
R2P48	19" EIA rack, aluminum. Dimensions: 48.0"H x 20.3"W x 3.0"D (1219mm x 514mm x 76mm).	24	1

6" Deep Channel Rack

R2P6S	19" EIA rack, 6" channel, steel. Dimensions: 84.0"H x 20.3"W x 6"D (2134mm x 514mm x 152mm).	45	1
R2P6S96	19" EIA rack, 6" channel, steel. Dimensions: 96.0"H x 20.3"W x 6"D (2438mm x 514mm x 152mm).	52	1

Rack Mount Shelves

SRM19FM1	19" front mount shelf, steel. Dimensions: 1.7"H x 19.0"W x 15.2"D (44mm x 483mm x 385mm). Load rating 30 lbs. (13.6 kg).	1	1
SRM19FM2	19" front mount shelf, steel. Dimensions: 3.5"H x 19.0"W x 15.2"D (88mm x 483mm x 385mm). Load rating 50 lbs. (22.7 kg).	2	1
SRM19CMV3	19" cantilevered shelf, vented aluminum. Includes two-piece shelf that mounts to front and back of EIA racks. Dimensions: 5.2"H x 19.2"W x 12.5"D (133mm x 489mm x 316mm). Load rating 200 lbs. (90.9 kg).	3	1
SRM19CM3	19" cantilevered shelf, aluminum. Includes two-piece shelf that mounts to front and back of EIA racks. Dimensions: 5.2"H x 19.2"W x 12.5"D (133mm x 489mm x 316mm). Load rating 200 lbs. (90.9 kg).	3	1
SRM19X18A1	19" adjustable mount shelf, steel, mounts to front and back of EIA racks. Dimensions: 1.8"H x 19.0"W x 18.0"D (44mm x 483mm x 457mm). Load rating 250 lbs. (113.6 kg).	1	1
SRM19X25A1	19" adjustable mount shelf, steel, mounts to front and back of EIA racks. Dimensions: 1.8"H x 19.0"W x 25.0"D (44mm x 483mm x 635mm). Load rating 250 lbs. (113.6 kg). Load rating 250 lbs. (113.6 kg).	1	1

Accessories

RFAKIT	Rack anchor kit for concrete floor (set of four).	—	1
R2PPDUB	Power Distribution Unit (PDU) bracket for 2 and 4 post racks (set of two).	—	1
PE2VWF	Waterfall trough for use with 2-post and 4-post racks and Patch-Runner 2 Enhanced Vertical Cable Managers	—	1
R2PPR2VWF	Waterfall Trough for 2 Post Rack and PatchRunner™ 2 Vertical Cable Managers.	—	1
S1224-C	#12-24 x .5" mounting screws.	—	100

‡One rack space = 1.75" (44.45mm).

All product color is black.

7ft 2-post rack is available in white. PN: R2PWH.

High Capacity Horizontal Cable Management Systems

NetManager™ High Capacity Horizontal Cable Managers

- Innovative inset fingers slope inward toward back of managers offering unobstructed access to network cabling for easier moves, adds, and changes
- Large front finger openings easily accommodate Category 6A and Category 6 cables, speeding installation and reducing maintenance costs
- Rear cable management finger spacing utilizes open D-rings for greater accessibility
- Can be used to create large capacity horizontal pathways for routing cable
- Front and rear dual hinged cover allows cable access without removing cover
- Built in cable retainers hold cable in place for easy moves, adds, and changes



NM1



NMF2WH



NMF3



NMF4WH



TLBP1



TLBP2



NM1B



NM3B

Part Number	Part Description	No. of Rack Spaces‡	Std Pkg Qty.
-------------	------------------	---------------------	--------------

19" Manager, Front and Rear

NM1*	1.7"H x 19.0"W x 13.1"D (44mm x 482mm x 332mm).	1	1
NM2*	3.5"H x 19.0"W x 13.1"D (88mm x 482mm x 332mm).	2	1
NM3*	5.2"H x 19.0"W x 13.1"D (133mm x 482mm x 332mm).	3	1
NM4*	7.0"H x 19.0"W x 13.1"D (177mm x 482mm x 332mm).	4	1

19" Manager, Front Only

NMF1*	1.7"H x 19.0"W x 6.2"D (44mm x 482mm x 157mm).	1	1
NMF2*	3.5"H x 19.0"W x 6.2"D (88mm x 482mm x 157mm).	2	1
NMF3*	5.2"H x 19.0"W x 6.2"D (133mm x 482mm x 157mm).	3	1
NMF4*	7.0"H x 19.0"W x 6.2"D (177mm x 482mm x 157mm).	4	1

Tool-Less Blanking Panels

TLBP1S-V	19" (483mm) width for 3/8" cage nut holes.	1	5
TLBP2S-V	19" (483mm) width for 3/8" cage nut holes.	2	5
TLBP1R-V	19" (483mm) width for tapped rails.	1	5
TLBP2R-V	19" (483mm) width for tapped rails.	2	5

Accessories

NM1B	Front to rear pass through blanking panel for NetManager™ High Capacity Horizontal Cable Managers, NM1 and NMF1.	1
NM2B	Front to rear pass through blanking panel for NetManager™ High Capacity Horizontal Cable Managers, NM2 and NMF2.	1
NM3B	Front to rear pass through blanking panel for NetManager™ High Capacity Horizontal Cable Managers, NM3 and NMF3.	1
NM4B	Front to rear pass through blanking panel for NetManager™ High Capacity Horizontal Cable Managers, NM4 and NMF4.	1

*Also available in white. Add "WH" to end of part number.

‡One rack space = 1.75" (44.45mm).

All product color is black.

Horizontal Cable Management Systems

PatchLink™ Horizontal Cable Managers

- Dual-hinged cover allows cable access without removing cover
- Rounded edges on fingers protect cables from snags and damage to cable
- Flexible fingers allow easy installation and removal of cables
- Pass-through holes allow front to rear cabling
- Covers and #12-24 mounting screws included
- Bulk package options minimize packaging on-site

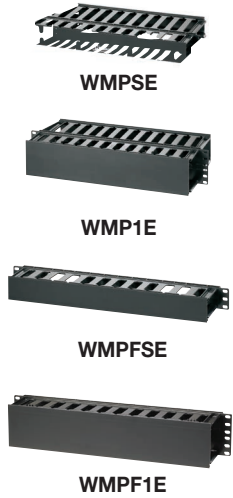

Part Number	Part Description	No. of Rack Spaces‡	Std Pkg Qty.
19" Manager, Front and Rear			
WMPSE	1.7"H x 19.0"W x 8.9"D (44mm x 483mm x 226mm).	1	1
WMP1E	3.5"H x 19.0"W x 8.9"D (89mm x 483mm x 226mm).	2	1
19" Manager, Front Only			
WMPFSE	1.7"H x 19.0"W x 3.7"D (44mm x 483mm x 94mm).	1	1
WMPF1E	3.5"H x 19.0"W x 3.7"D (89mm x 483mm x 94mm).	2	1

‡One rack space = 1.75" (44.45mm).
All product color is black.

Open-Access™ Horizontal Cable Managers

- D-ring managers provide an open and efficient way to manage power, coaxial, and communications cables
- Optional snap-on cover
- Optional front and rear managers
- Pass-through holes allow front to rear cabling
- Hardware included

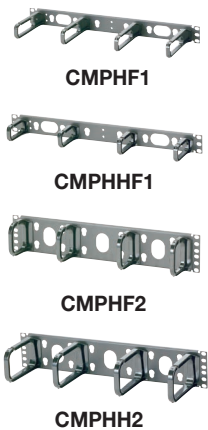

Part Number	Part Description	No. of Rack Spaces‡	Std Pkg Qty.
19" Manager, Front and Rear			
CMPH1	1.7"H x 19.0"W x 8.6"D (44mm x 483mm x 218mm).	1	1
CMPH2	3.5"H x 19.0"W x 8.6"D (88mm x 483mm x 218mm).	2	1
19" Manager, Front Only			
CMPHF1	1.7"H x 19.0"W x 3.4"D (44mm x 483mm x 87mm).	1	1
CMPHHF1	1.7"H x 19.0"W x 5.7"D (44mm x 483mm x 144mm).	1	1
CMPHF2	3.5"H x 19.0"W x 3.4"D (88mm x 483mm x 87mm).	2	1
CMPHH2	3.5"H x 19.0"W x 5.7"D (88mm x 483mm x 144mm).	2	1

‡One rack space = 1.75" (44.45mm).
All product color is black.

PatchRunner™ 2 Accessories



PR2VEP



R2PPR2VWF



R4PPR2VWF



PR2VBPK



PRSP7



WR5E-X

Part Number	Part Description	Color	Std. Pkg. Qty.	Std. Ctn. Qty.
Accessories				
PR2VEP	PatchRunner™ 2 End Panel for use with 45 RU managers.	Black	1	—
PR2VEPWH	PatchRunner™ 2 End Panel for use with 45 RU managers.	White	1	—
PR2VEP96	PatchRunner™ 2 End Panel for use with 52 RU managers.	Black	1	—
PR2VEP96WH	PatchRunner™ 2 End Panel for use with 52 RU managers.	White	1	—
PE2VEP	PatchRunner™ 2 Enhanced End Panel for use with 45 RU managers.	Black	1	—
PE2VEPWH	PatchRunner™ 2 Enhanced End Panel for use with 45 RU managers.	White	1	—
PE2VEP96	PatchRunner™ 2 Enhanced End Panel for use with 52 RU managers.	Black	1	—
PE2VEP96WH	PatchRunner™ 2 Enhanced End Panel for use with 52 RU managers.	White	1	—
R2PPR2VWF	PatchRunner™ 2 Waterfall for use with 2 post racks.	Black	1	—
R2PPR2VWFWH	PatchRunner™ 2 Waterfall for use with 2 post racks.	White	1	—
R4PPR2VWF	PatchRunner™ 2 Waterfall for use with R4P-style 4 post racks.	Black	1	—
R4PPR2VWFWH	PatchRunner™ 2 Waterfall for use with R4P-style 4 post racks.	White	1	—
PE2VWF	PatchRunner™ 2 Enhanced Waterfall for use with 2 post and 4 post racks.	Black	1	—
PE2VWFWH	PatchRunner™ 2 Enhanced Waterfall for use with 2 post and 4 post racks.	White	1	—
PR2VBPK	PatchRunner™ 2 Pass-Through Hole Blanking Plugs, kit of five plugs.	Black	1	10
PRSP7	Molded plastic slack spool, 7" depth.	Black	1	10
PRSP5	Molded plastic slack spool, 5" depth.	Black	1	10
WR5E-X	Snap-on finger cable retainers.	Black	10	100

PatchRunner™ 2 Enhanced Vertical Cable Manager

Specifications

- Dual-sided cable managers, having 60% of total cable capacity on one side and 40% on the other, allow optimized capacity placement on either side of the rack
- Cable managers have multiple mounting locations to the side of the rack, allowing optimal cable routing and space utilization
- When using a dual-sided cable manager in an inter-connect network architecture, the 60% side of the cable manager can be orientated towards the patching side of the rack to manage a higher number of patch cords
- When using a dual-sided cable manager in a cross-connect network architecture, the 60% side of the cable manager can be orientated towards the cabling side of the rack to manage a higher number of cables

4 Post Rack

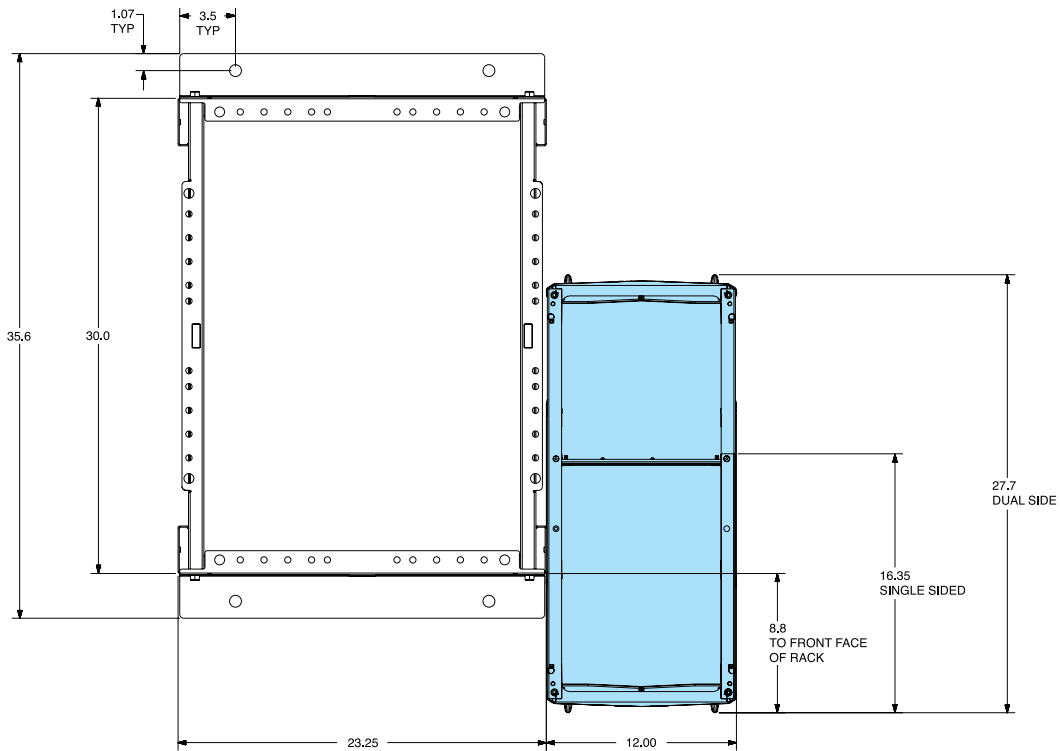

2 Post Rack

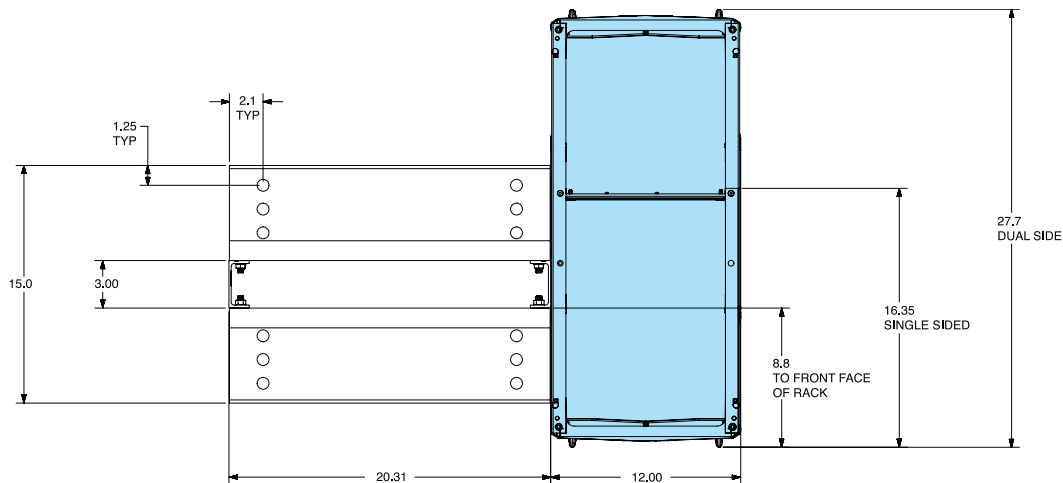

PatchRunner™ 2 Vertical Cable Manager

Specifications

- PatchRunner™ 2 Vertical Cable Managers are specifically designed for cable capacities typically found in telecommunication rooms using medium to large enterprise switches

4 Post Rack

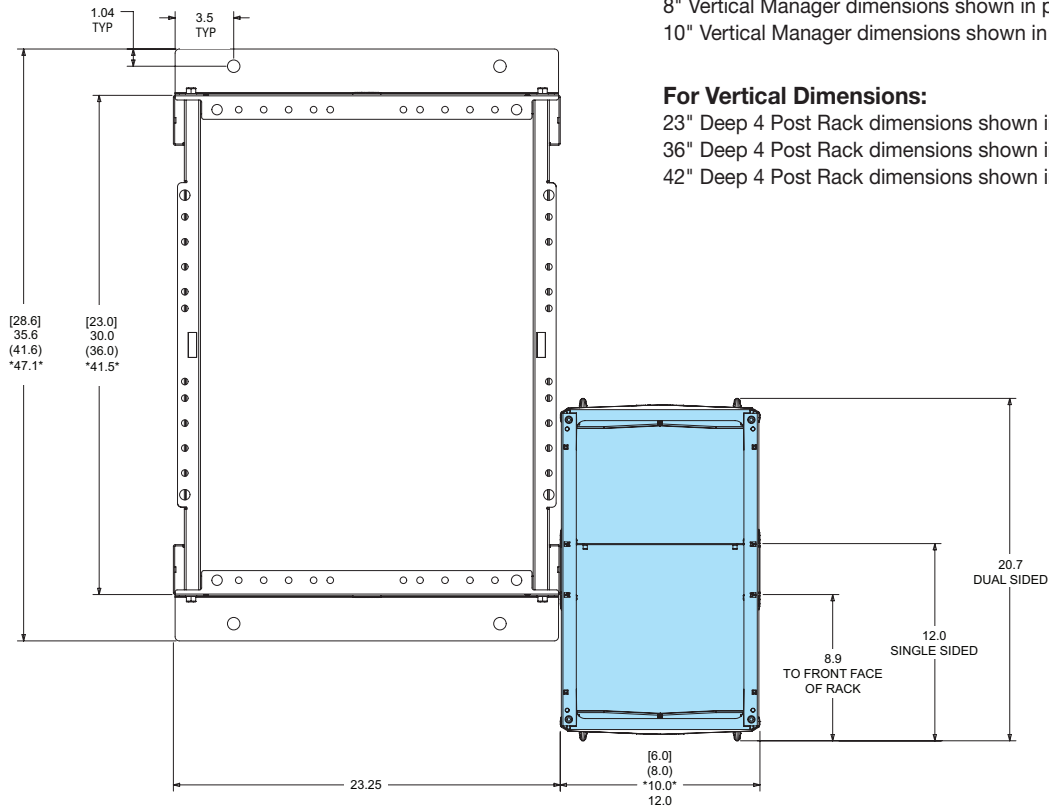

2 Post Rack

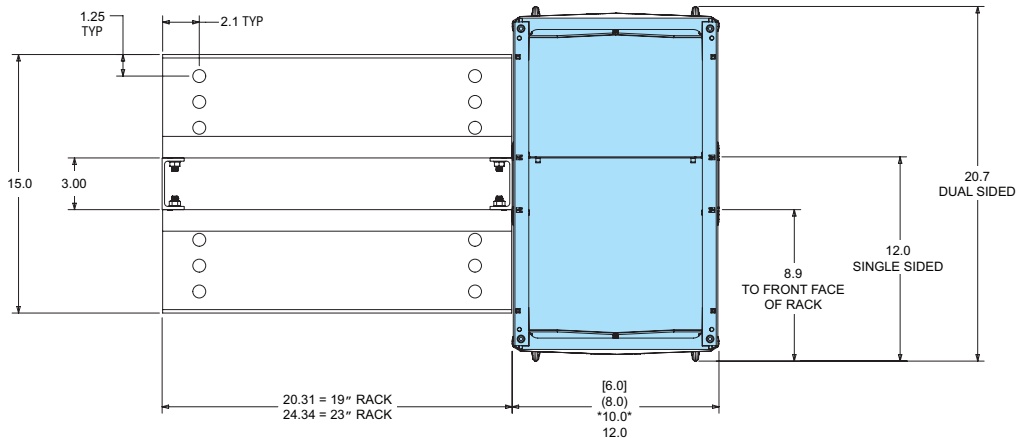

Cable Capacity Charts (inches)

Product Family	Part Number	Description	Recommended Cable Fill (30%)								Maximum Cable Fill (50%)							
			Front Side								Rear Side							
			Cat. 6A (28 AWG - 0.185")		Cat. 6A (24 AWG - 0.275")		Cat. 6 (28 AWG - 0.150")		Cat. 6 (24 AWG - 0.235")		Cat. 6A (28 AWG - 0.185")		Cat. 6A (24 AWG - 0.275")		Cat. 6 (28 AWG - 0.150")		Cat. 6 (24 AWG - 0.235")	
PR2V PatchRunner™ 2 Vertical Cable Managers	PR2VD06	6" wide	503	839	227	379	765	1276	312	520	304	507	137	229	462	771	188	314
	PR2VFD06	6" wide, front only	503	839	227	379	765	1276	312	520	0	0	0	0	0	0	0	0
	PR2VD08	8" wide	711	1185	321	536	1081	1802	440	734	443	739	200	334	674	1124	274	457
	PR2VFD08	8" wide, front only	711	1185	321	536	1081	1802	440	734	0	0	0	0	0	0	0	0
	PR2VD10	10" wide	918	1531	415	692	1397	2328	569	948	582	971	263	439	886	1477	361	601
	PR2VFD10	10" wide, front only	918	1531	415	692	1397	2328	569	948	0	0	0	0	0	0	0	0
	PR2VD12	12" wide	1126	1876	509	849	1712	2854	697	1163	721	1203	326	544	1098	1830	447	745
	PR2VFD12	12" wide, front only	1126	1876	509	849	1712	2854	697	1163	0	0	0	0	0	0	0	0
PE2V PatchRunner™ 2 Enhanced Vertical Cable Managers with Vertical Patching	PE2VD06	6" wide	737	1229	333	556	1122	1870	457	762	494	823	223	372	751	1252	306	510
	PE2VFD06	6" wide, front only	737	1229	333	556	1122	1870	457	762	0	0	0	0	0	0	0	0
	PE2VD08	8" wide	1032	1720	467	778	1570	2616	639	1066	704	1173	318	531	1071	1785	436	727
	PE2VFD08	8" wide, front only	1032	1720	467	778	1570	2616	639	1066	0	0	0	0	0	0	0	0
	PE2VD10	10" wide	1326	2210	600	1000	2017	3363	822	1370	9114	1524	413	689	1391	2319	566	944
	PE2VFD10	10" wide, front only	1326	2210	600	1000	2017	3363	822	1370	0	0	0	0	0	0	0	0
	PE2VD12	12" wide	1620	2701	733	1222	2465	4109	1004	1674	1124	1873	508	848	1710	2850	696	1161
	PE2VFD12	12" wide, front only	1620	2701	733	1222	2465	4109	1004	1674	0	0	0	0	0	0	0	0

Note: Door brackets and cable slack spools reduce cable capacity.

WMP PatchLink™ Horizontal Cable Managers	WMP1E	2RU, front/rear	84	141	38	63	129	215	52	87	118	197	53	89	179	299	73	122
	WMPF1E	2RU, front only	84	141	38	63	129	215	52	87	0	0	0	0	0	0	0	0
	WMPSE	1RU, front/rear	39	65	17	29	59	99	24	40	70	117	31	53	106	178	43	72
	WMPFSE	1RU, front only	39	65	17	29	59	99	24	40	0	0	0	0	0	0	0	0

Note: Rear section may be partially blocked by rack posts.

NM NetManager™ High Capacity Horizontal Cable Managers	NM1	1RU, front/rear	36	61	16	27	56	93	22	38	45	76	20	34	69	116	28	47
	NMF1	1RU, front only	36	61	16	27	56	93	22	38	0	0	0	0	0	0	0	0
	NM2	2RU, front/rear	109	182	49	82	166	277	67	112	123	206	56	93	188	314	76	127
	NMF2	2RU, front only	109	182	49	82	166	277	67	112	0	0	0	0	0	0	0	0
	NM3	3RU, front/rear	193	321	87	145	293	489	119	199	245	409	111	185	373	622	152	253
	NMF3	3RU, front only	193	321	87	145	293	489	119	199	0	0	0	0	0	0	0	0
	NM4	4RU, front/rear	271	452	122	204	412	687	168	280	356	593	161	268	541	902	220	367
	NMF4	4RU, front only	271	452	122	204	412	687	168	280	0	0	0	0	0	0	0	0

Note: Rear section may be partially blocked by rack posts.

CMPH Open-Access™ Horizontal Cable Managers	CMPH1	1RU, front/rear	25	42	11	19	39	65	15	26	32	53	14	24	49	82	20	33
	CMPHF1	1RU, front only	25	42	11	19	39	65	15	26	0	0	0	0	0	0	0	0
	CMPH2	2RU, front/rear	59	98	26	44	89	149	36	61	120	200	54	90	183	305	74	124
	CMPHF2	2RU, front only	59	98	26	44	89	149	36	61	0	0	0	0	0	0	0	0
	CMPHH2	2RU, front only, larger D-rings	120	200	54	90	183	305	74	124	0	0	0	0	0	0	0	0
	CMPHHF1	1RU, front only, larger D-rings	32	53	14	24	49	82	20	33	0	0	0	0	0	0	0	0

Note: Rear section may be partially blocked by rack posts.

Cable Capacity Charts (millimeters)



Product Family	Part Number	Description	Recommended Cable Fill (30%)								Maximum Cable Fill (50%)							
			Front Side								Rear Side							
			Cat. 6A (28 AWG - 4,70mm)		Cat. 6A (24 AWG - 6,99mm)		Cat. 6 (28 AWG - 3,81mm)		Cat. 6 (24 AWG - 5,97mm)		Cat. 6A (28 AWG - 4,70mm)		Cat. 6A (24 AWG - 6,99mm)		Cat. 6 (28 AWG - 3,81mm)		Cat. 6 (24 AWG - 5,97mm)	
PR2V PatchRunner™ 2 Vertical Cable Managers	PR2VD06	152mm wide	503	839	227	379	765	1276	312	520	304	507	137	229	462	771	188	314
	PR2VFD06	152mm wide, front only	503	839	227	379	765	1276	312	520	0	0	0	0	0	0	0	0
	PR2VD08	203mm wide	711	1185	321	536	1081	1802	440	734	443	739	200	334	674	1124	274	457
	PR2VFD08	203mm wide, front only	711	1185	321	536	1081	1802	440	734	0	0	0	0	0	0	0	0
	PR2VD10	254mm wide	918	1531	415	692	1397	2328	569	948	582	971	263	439	886	1477	361	601
	PR2VFD10	254mm wide, front only	918	1531	415	692	1397	2328	569	948	0	0	0	0	0	0	0	0
	PR2VD12	305mm wide	1126	1876	509	849	1712	2854	697	1163	721	1203	326	544	1098	1830	447	745
	PR2VFD12	305mm wide, front only	1126	1876	509	849	1712	2854	697	1163	0	0	0	0	0	0	0	0
PE2V PatchRunner™ 2 Enhanced Vertical Cable Managers with Vertical Patching	PE2VD06	152mm wide	737	1229	333	555	1122	1870	457	761	493	823	223	372	751	1252	306	510
	PE2VFD06	152mm wide, front only	737	1229	333	555	1122	1870	457	761	0	0	0	0	0	0	0	0
	PE2VD08	203mm wide	1031	1719	466	777	1570	2616	639	1065	703	1173	318	530	1071	1785	436	727
	PE2VFD08	203mm wide, front only	1031	1719	466	777	1570	2616	639	1065	0	0	0	0	0	0	0	0
	PE2VD10	254mm wide	1325	2209	599	999	2017	3363	821	1369	914	1523	413	688	1391	2319	566	944
	PE2VFD10	254mm wide, front only	1325	2209	599	999	2017	3363	821	1369	0	0	0	0	0	0	0	0
	PE2VD12	305mm wide	1620	2700	732	1220	2465	4109	1004	1673	1123	1872	508	846	1710	2850	696	1160
	PE2VFD12	305mm wide, front only	1620	2700	732	1220	2465	4109	1004	1673	0	0	0	0	0	0	0	0

Note: Door brackets and cable slack spools reduce cable capacity.

WMP PatchLink™ Horizontal Cable Managers	WMP1E	2RU, front/rear	84	141	38	63	129	215	52	87	118	197	53	89	179	299	73	122
	WMPF1E	2RU, front only	84	141	38	63	129	215	52	87	0	0	0	0	0	0	0	0
	WMPSE	1RU, front/rear	39	65	17	29	59	99	24	40	70	117	31	53	106	178	43	72
	WMPFSE	1RU, front only	39	65	17	29	59	99	24	40	0	0	0	0	0	0	0	0

Note: Rear section may be partially blocked by rack posts.

NM NetManager™ High Capacity Horizontal Cable Managers	NM1	1RU, front/rear	36	61	16	27	56	93	22	38	45	76	20	34	69	116	28	47
	NMF1	1RU, front only	36	61	16	27	56	93	22	38	0	0	0	0	0	0	0	0
	NM2	2RU, front/rear	109	182	49	82	166	277	67	112	123	206	56	93	188	314	76	127
	NMF2	2RU, front only	109	182	49	82	166	277	67	112	0	0	0	0	0	0	0	0
	NM3	3RU, front/rear	193	321	87	145	293	489	119	199	245	409	111	185	373	622	152	253
	NMF3	3RU, front only	193	321	87	145	293	489	119	199	0	0	0	0	0	0	0	0
	NM4	4RU, front/rear	271	452	122	204	412	687	168	280	356	593	161	268	541	902	220	367
	NMF4	4RU, front only	271	452	122	204	412	687	168	280	0	0	0	0	0	0	0	0

Note: Rear section may be partially blocked by rack posts.

CMPH Open-Access™ Horizontal Cable Managers	CMPH1	1RU, front/rear	25	42	11	19	39	65	15	26	32	53	14	24	49	82	20	33
	CMPHF1	1RU, front only	25	42	11	19	39	65	15	26	0	0	0	0	0	0	0	0
	CMPH2	2RU, front/rear	59	98	26	44	89	149	36	61	120	200	54	90	183	305	74	124
	CMPHF2	2RU, front only	59	98	26	44	89	149	36	61	0	0	0	0	0	0	0	0
	CMPHH2	2RU, front only, larger D-rings	120	200	54	90	183	305	74	124	0	0	0	0	0	0	0	0
	CMPHHF1	1RU, front only, larger D-rings	32	53	14	24	49	82	20	33	0	0	0	0	0	0	0	0

Note: Rear section may be partially blocked by rack posts.

A background graphic consisting of a network of white dots connected by thin white lines, set against a light blue gradient. The dots vary in size, and the lines form a complex, interconnected web. The graphic is most dense on the left side and fades towards the right.

PANDUIT®

**Panduit Corp.
World Headquarters
Tinley Park, IL 60487**

**cs@panduit.com
US and Canada: 800.777.3300
Europe, Middle East, and Africa:
44.20.8601.7200
Latin America: 52.33.3777.6000
Asia Pacific: 65.6305.7575**

www.panduit.com

All trademarks, service marks, trade names, product names, and logos appearing in this document are the property of their respective owners.

© 2019 Panduit Corp. ALL RIGHTS RESERVED. Printed in the U.S.A. RKCB46--SA-ENG 4/2019